

NOSE ASSEMBLY DATA SHEET

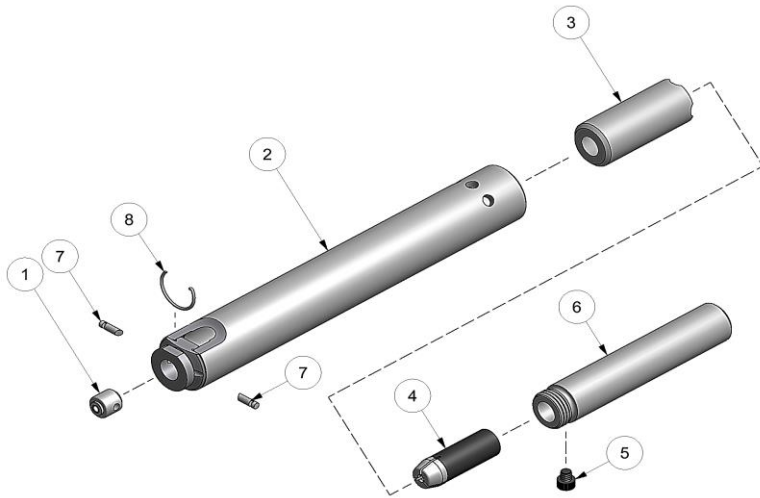
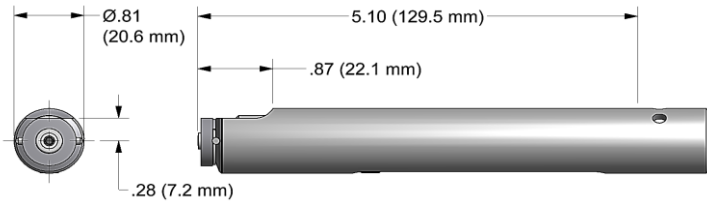

ASSEMBLY:

Note: If nose assy is assembled as it is when purchased new, follow steps 3-5 to attach to tool.

1. Insert super grip jaw assy (4) into collet (3).
2. Tighten assembled collet (3) to drawbolt (6). Thread screw (5) into drawbolt (6).
3. Tighten assembled collet (3) & drawbolt (6) to piston on tool.
4. Slide anvil holder (2) over assembled collet (3).
5. Align holes on anvil holder (2) with holes in nose fitting on tool and tighten two s.h.c.s. to lock into place.

DISASSEMBLY:

Reverse assembly instructions.



5/10 REV 1/17

GAGE BILT
MADE in USA

44766 Centre Court Clinton Twp. MI 48038 USA
Ph: +1 (586) 226-1500 Fax: +1 (586) 226-1505
solutions@gagebilt.com / www.gagebilt.com

Type:		Fastener:		Recommended Tool: GB740
Single Action 1/8" Ø		NAS1398A/1399A RV 1000/1100 & 1200		
Ref. No.	Qty.	Description		4A-740B-52
1	1	Anvil-Insert Universal		10304
2	1	Anvil Holder		10954
3	1	Collet		20330
4	1	Super Grip Jaw Assy		30425-CS
5	1	Screw		400046
6	1	Drawbolt		70316
7	2	Stem Stop		15503
8	1	Spring-Retaining		50302